

A	B	C (mm)		D
1	S228-5506	401	80	1/1
2	S271-0003	565	520	1/1
3	S271-0006	565	320	1/1
4	S271-0007	1171	520	1/1
5	S271-0008	565	320	1/1
6	S271-1001	1909	401	1/1
7	S271-1003	1816,5	381	1/1
8	S271-1004	1909	401	1/1
9	S271-1005	565	395	1/1
10	S271-1008	565	395	1/1
11	S271-2002	964	401	1/1
12	S271-2003	315	397	1/1
13	S271-2004	315	397	1/1
14	S271-3004	932	381	1/1
15	S271-3006	557	371	1/1
16	S271-3007	357	371	1/1
17	S271-3008	558	381	1/1
18	S271-3009	358	381	1/1
19	S271-3010	264	375	1/1
20	S271-5003	1914	80	1/1
21	S271-5005	1914	58,	1/1
22	S271-5006	1924	80	1/1
23	S271-5010	1924	80	1/1
24	S271-5012	1008,	80	1/1
25	S271-5013	849	80,	1/1
26	S271-5014	930	40	1/1
27	S271-5015	1914	80	1/1
28	S271-5023	263	80,	1/1
29	S271-5059	155	80	1/1
30	S271-9002	1836,	942	1/1
31	S271-5093	155	80	1/1

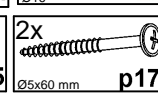

1

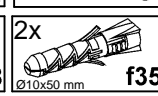
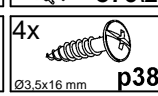
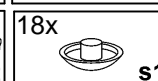
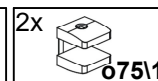
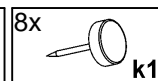
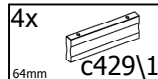
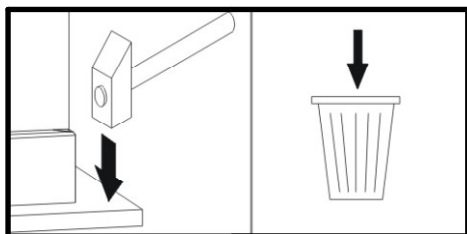
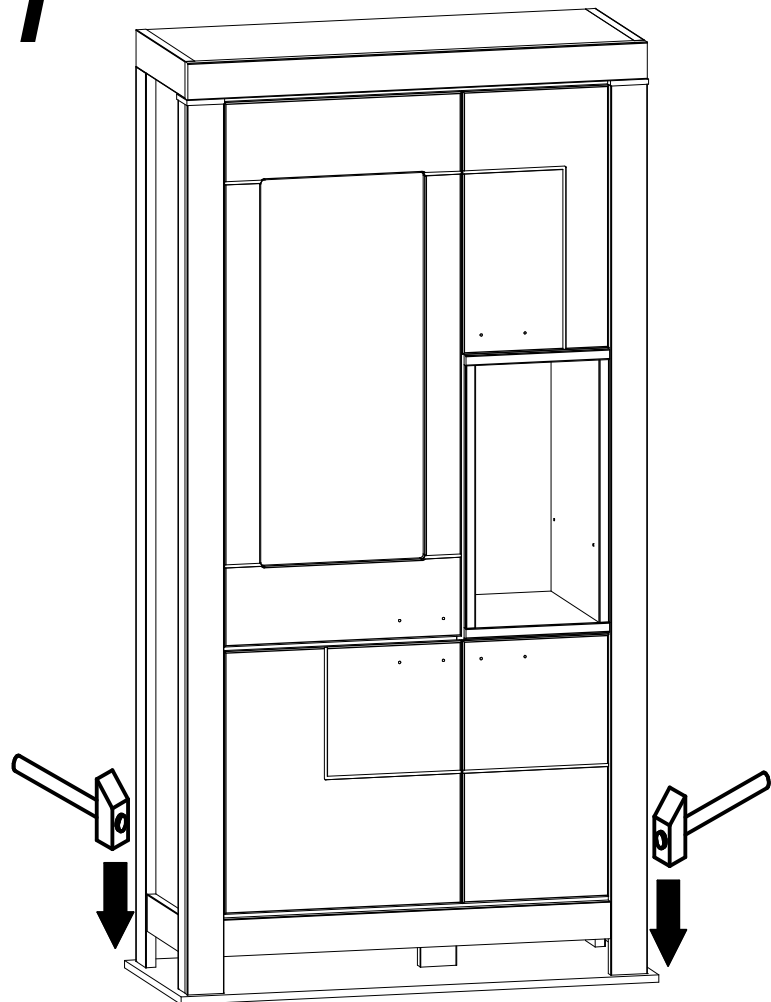

2

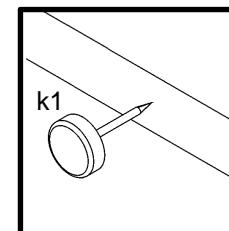
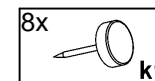
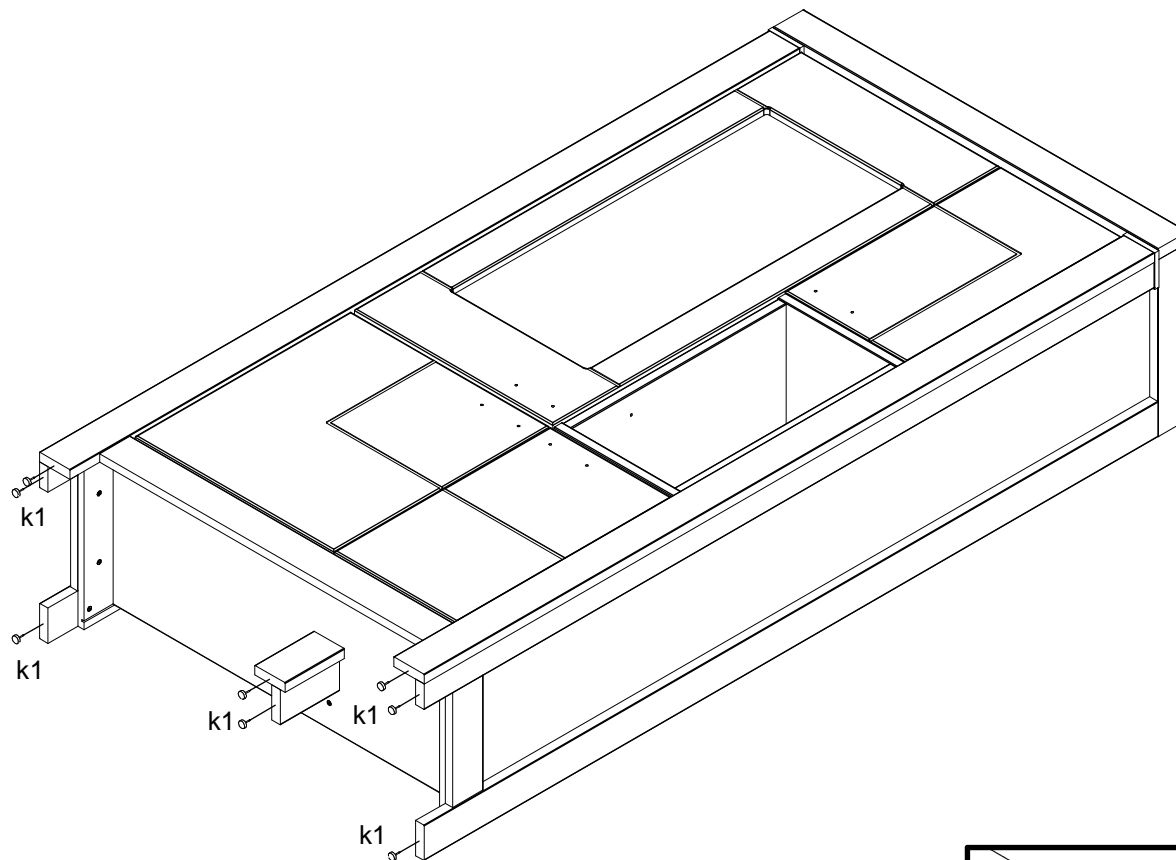
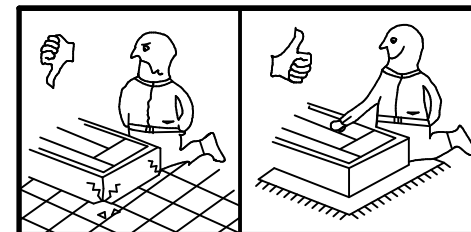

3

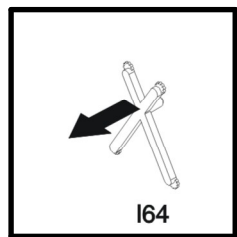
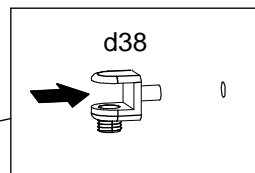
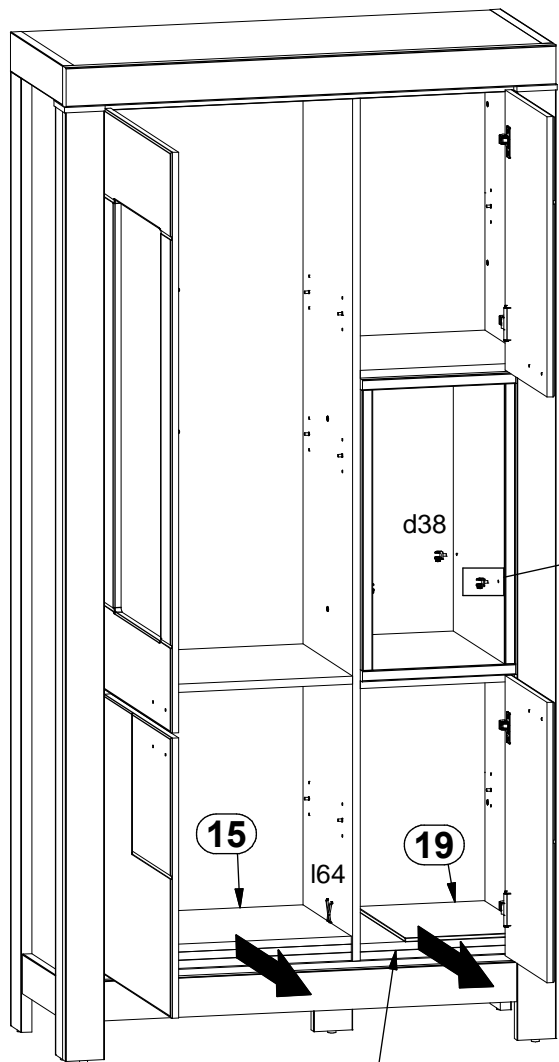

4

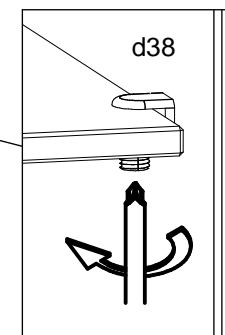
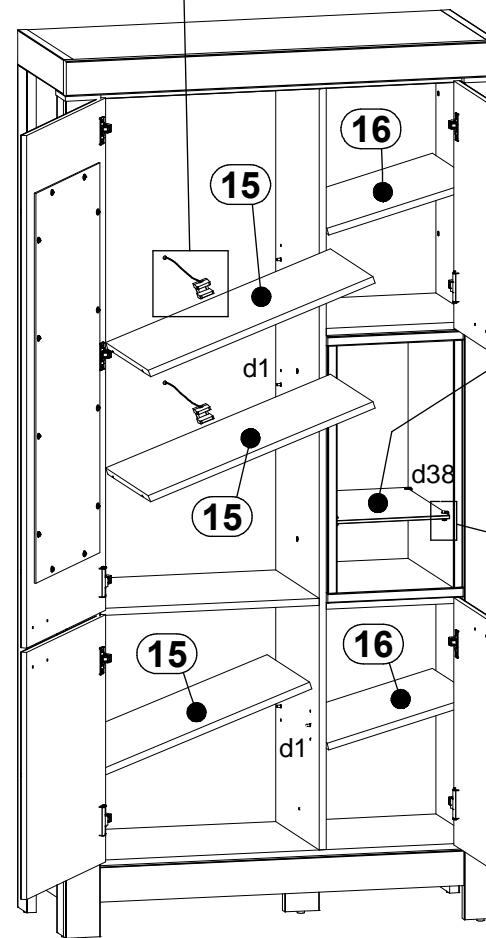
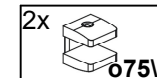
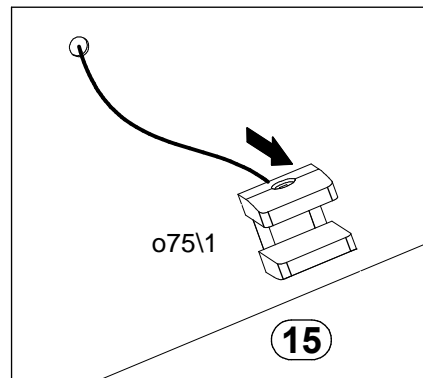

5

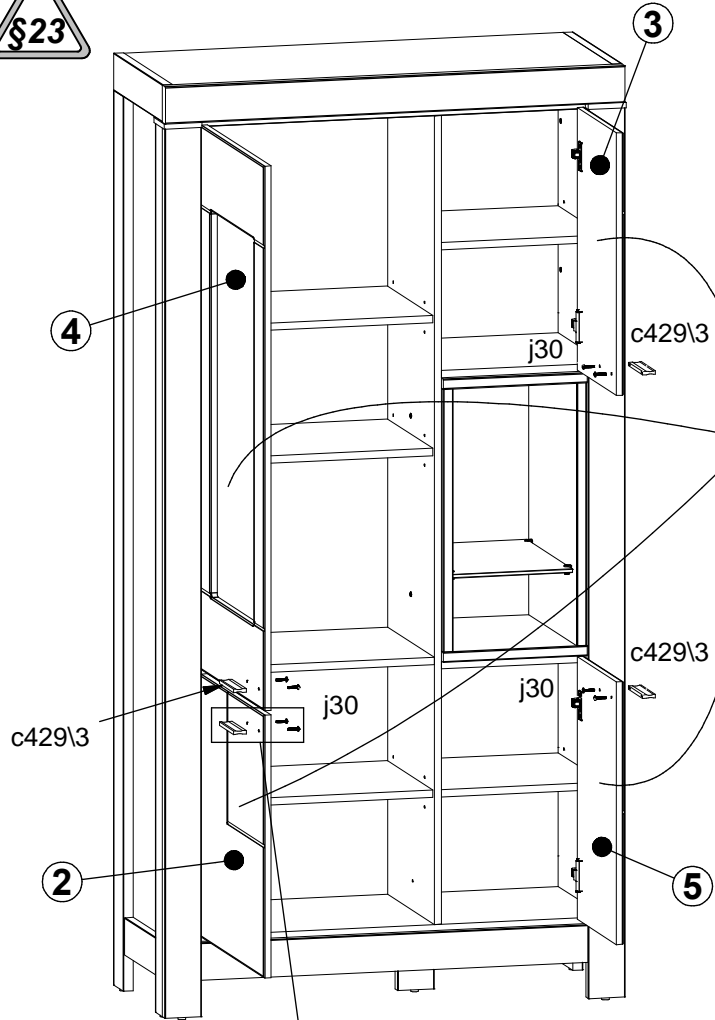

!
40543W02

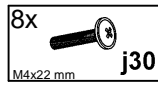
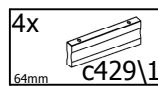
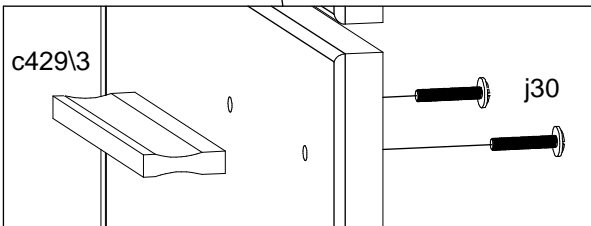
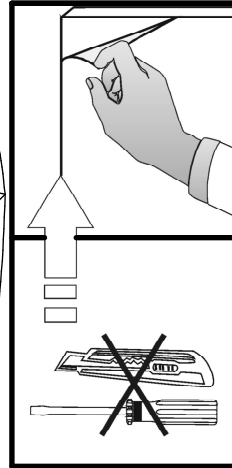

6

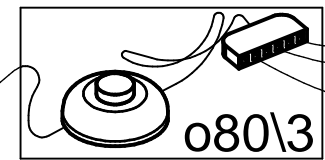
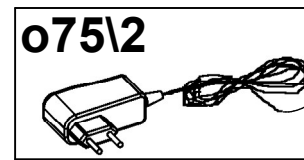
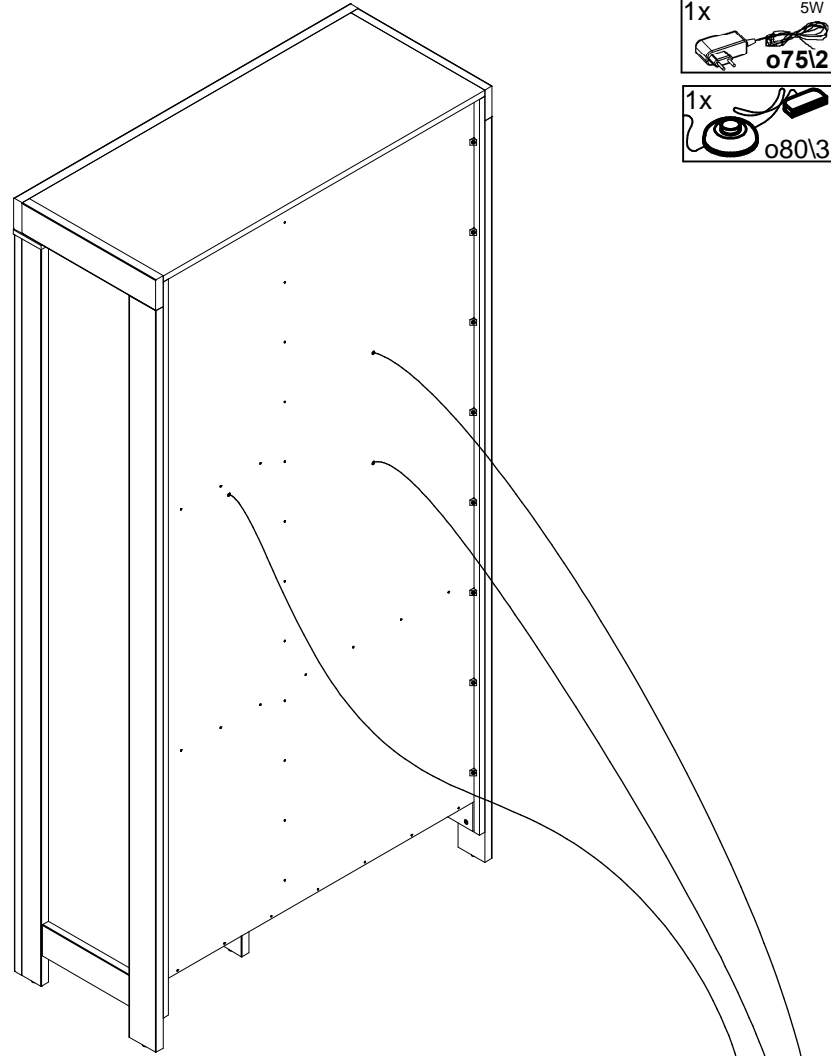
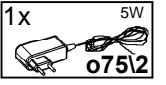

7

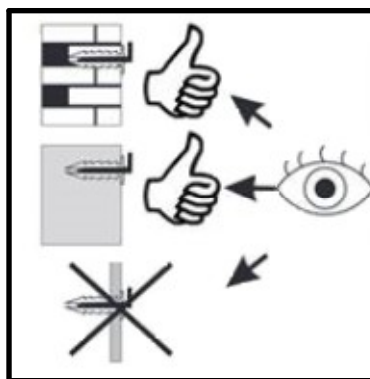
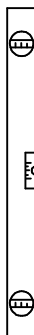
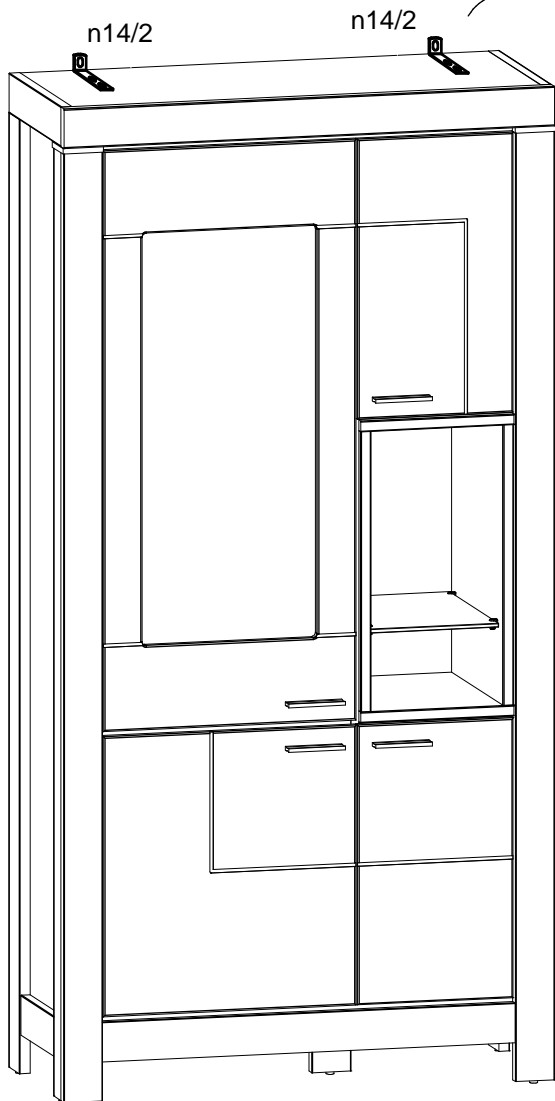
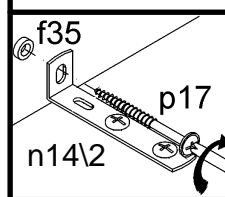
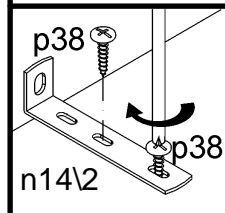
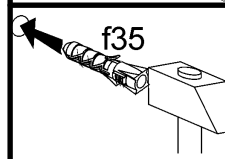
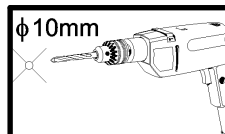
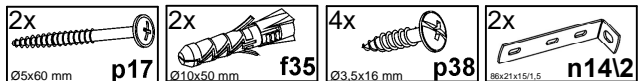

8

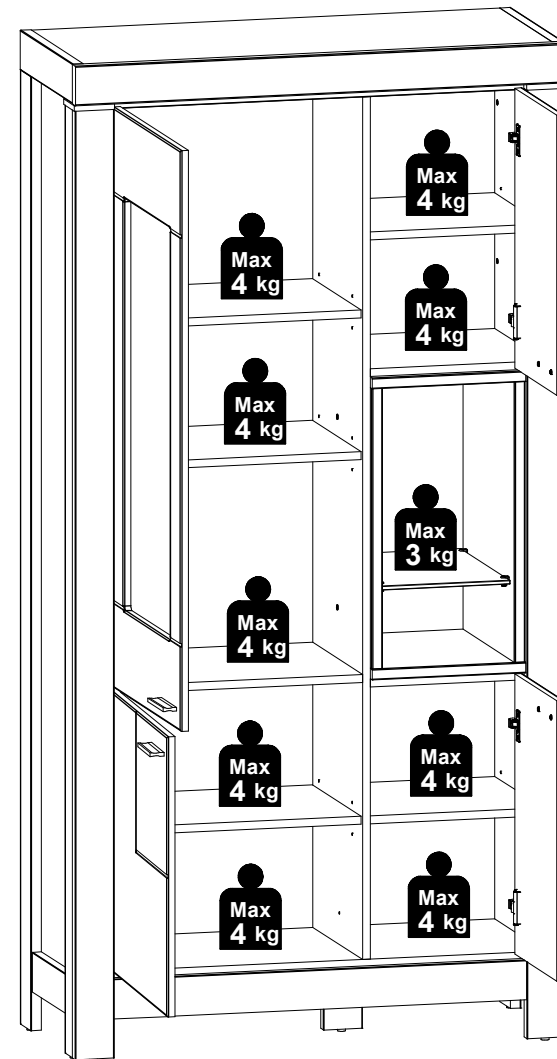

9

